

RJ/SJ

RJ Series Slim Power Relays
SJ Series Relay Sockets

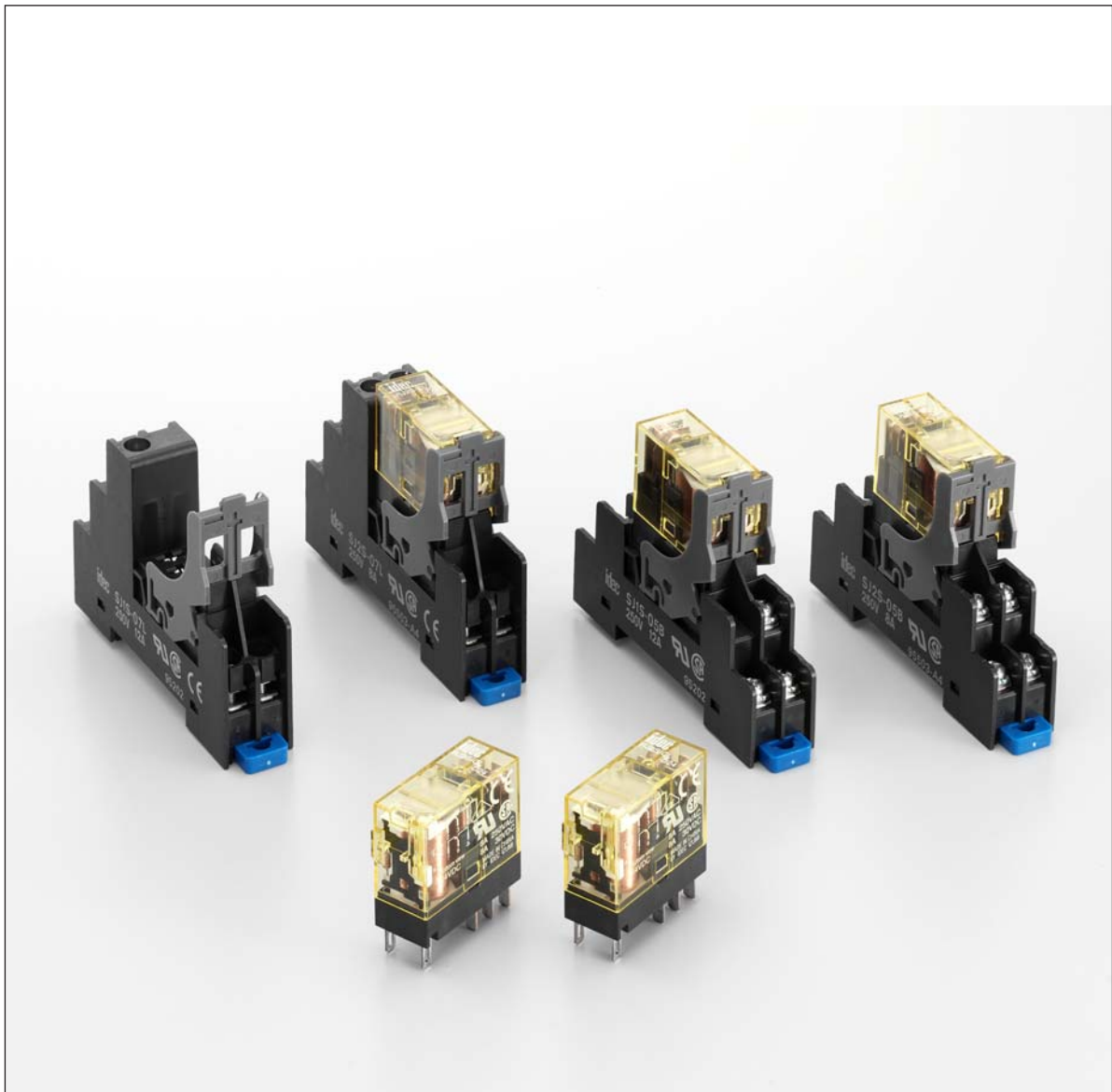

RJ Series Slim Power Relays

Compact housing, large switching capacity.

Plug-in terminal relays suitable for control panels, machine tools, and a wide variety of applications.

Large Switching Capacity

Excellent Durability

Large Switching Capacity

Highly conductive materials ensure stable electric conduction of current.

Excellent Durability

Our unique return spring structure provides improved durability and reliability of all mechanical parts.

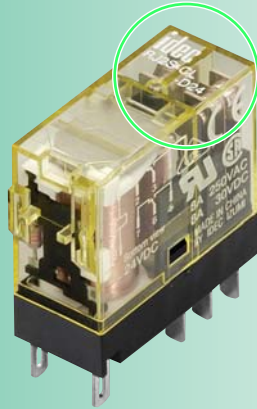

Two Bobbin Colors



Black: AC Coil

White: DC Coil



Large Switching Capacity vs. Competitors

(maximum allowable switching current)

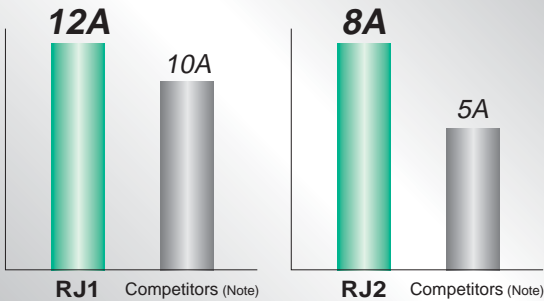

Note: According to published specifications in other manufacturers' catalogs.

Long Mechanical Life vs. Competitors

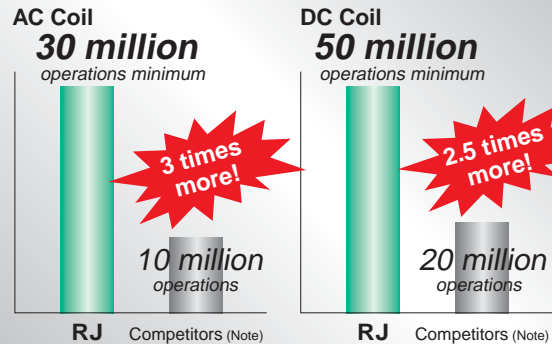

Note: According to published specifications in other manufacturers' catalogs.

High Visibility LED Indicator

IEC-compliant Green Indication

An RJ relay can be easily identified with the illuminating LED.

IEC-compliant Green Indication



Light Guide

Easy recognition with a large illumination area!



SJ Series Relay Sockets

Slim sockets save space.

RJ series relays can be mounted on DIN rails or panels using SJ series relay sockets.

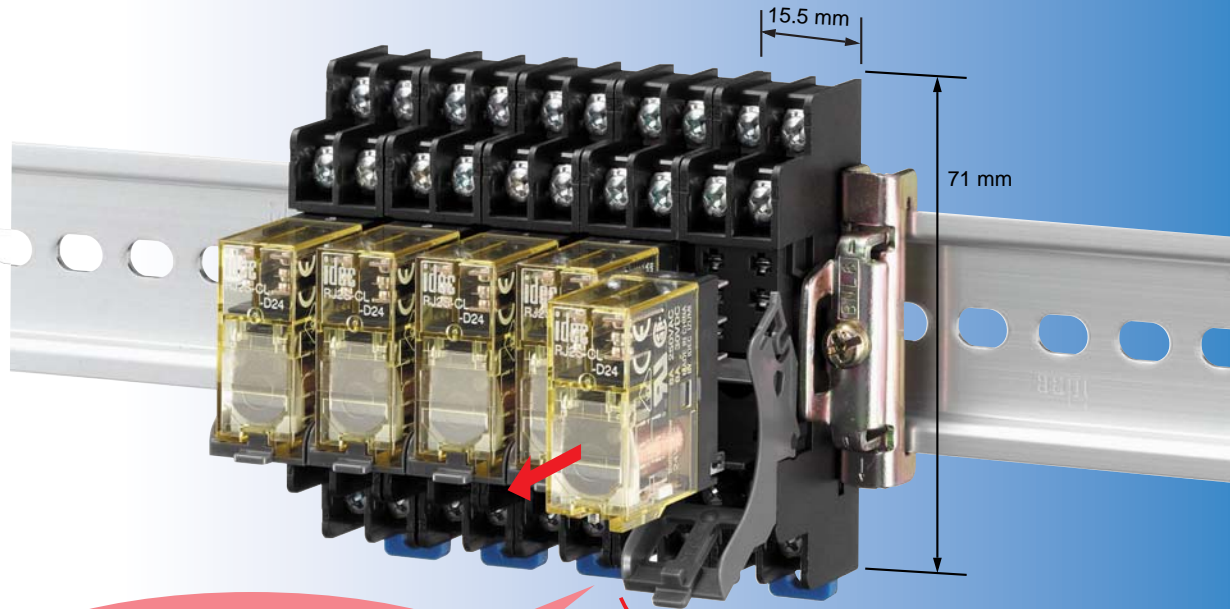

Release Lever

Relays can be easily removed using release levers.

Easy Wiring!

SJ Socket Versions

- Standard Screw Terminal Type

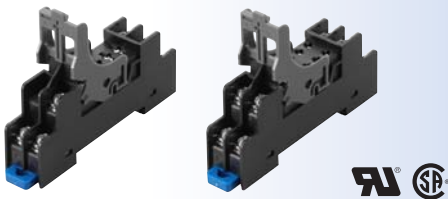

- Finger-safe Screw Terminal Type (IP20)

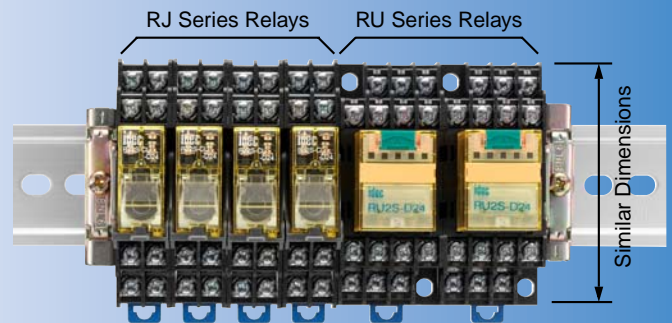
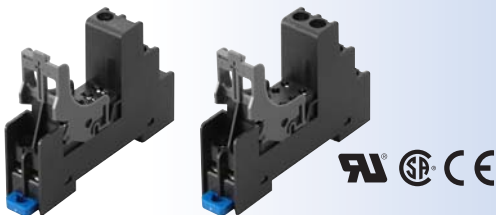

By combining with the RU series relays, the contact capacity increases and more contact configuration types become available. Because the screw terminal size is M3 on both sockets, wiring can be completed easily and efficiently.

RoHS directive compliant (2002/95/EC)





The RJ series relays and the SJ series sockets do not contain lead, cadmium, mercury, hexavalent chromium, PBB, or PBDE.

RJ Series Slim Power Relays

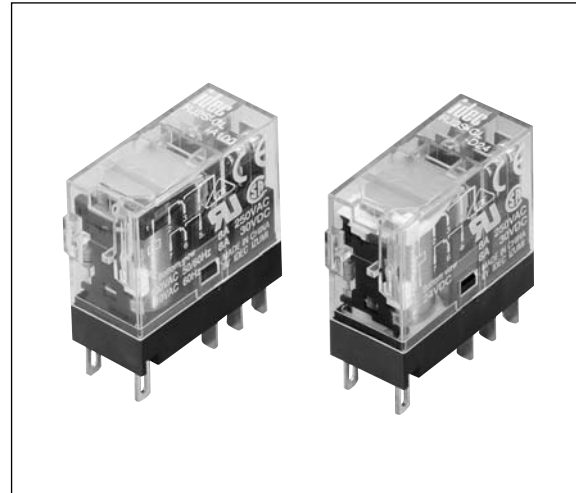
Compact and rugged power relays. Large switching capacity.

- Compact housing only 12.7-mm wide.
Large contact rating
RJ1S (1-pole): 12A
RJ2S (2-pole): 8A
- Non-polarized LED indicator available. IDEC's unique light guide structure enables high visibility of coil status from any direction.
- Excellent electrical and mechanical life.
Electrical life: 200,000 operations (AC load)
Mechanical life: 30 million operations (AC coil)
- Environmentally friendly, RoHS directive compliant (EU directive 2002/95/EC). Contains no lead, cadmium, mercury, hexavalent chromium, PBB or PBDE).
- Diode type
Diode reverse withstand voltage: 1000V
- UL recognized, CSA certified, EN compliant.



Standard	Mark	Certification Organization / File No.
UL508		UL File No. E55996
CSA C22.2 No. 14		1608322 (LR35144)
EN61810-1		VDE (REG.-Nr. B312)
		EC Low Voltage Directive

Types

• Plug-in Terminal Type

Type	1-pole (SPDT)		2-pole (DPDT)	
	Type No.	Code	Type No.	Code
Standard (with LED Indicator)	RJ1S-CL-*	A24 A110 A120 A220 A230 A240	RJ2S-CL-*	A24 A110 A120 A220 A230 A240
Simple (without LED Indicator)	RJ1S-C-*	D12 D24 D48 D100	RJ2S-C-*	D12 D24 D48 D100
With diode (DC coil only) (with LED indicator) A1: -, A2: +	RJ1S-CLD-*	D12 D24 D48 D100	RJ2S-CLD-*	D12 D24 D48 D100
With diode (DC coil only) A1: -, A2: +	RJ1S-CD-*		RJ2S-CD-*	
With diode (DC coil only) (with LED indicator) A1: +, A2: -	RJ1S-CLD1-*		RJ2S-CLD1-*	
With diode (DC coil only) A1: +, A2: -	RJ1S-CD1-*		RJ2S-CD1-*	

• Coil Voltage Code *

Code	Rated Coil Voltage
A24	24V AC
A110	110V AC
A120	120V AC
A220	220V AC
A230	230V AC
A240	240V AC
D12	12V DC
D24	24V DC
D48	48V DC
D100	100-110V DC

Note: Specify a coil voltage code in place of * in the Type No.

Contact Ratings

No. of Poles	Contact	Allowable Contact Power		Rated Load			Allowable Switching Current	Allowable Switching Voltage	Minimum Applicable Load (Note)
		Resistive Load	Inductive Load	Voltage	Resistive Load	Inductive Load cos ϕ = 0.3 L/R = 7 ms			
1	NO	3000VA AC 360W DC	1875VA AC 180W DC	250V AC	12A	7.5A	12A	250V AC 125V DC	5V DC, 100 mA (reference value)
				30V DC					
	NC	3000VA AC 180W DC	1875VA AC 90W DC	250V AC	6A	3A			
				30V DC					
2	NO	2000VA AC 240W DC	1000VA AC 120W DC	250V AC	8A	4A	8A	250V AC 125V DC	5V DC, 10 mA (reference value)
				30V DC					
	NC	2000VA AC 120W DC	1000VA AC 60W DC	250V AC	4A	2A			
				30V DC					

Note: Measured at operating frequency of 120 operations per minute (failure rate level P, reference value)

Approved Ratings

Voltage	UL				CSA								VDE			
	Resistive				Resistive				Inductive				Resistive		AC-15, DC-13 (Note)	
	RJ1		RJ2		RJ1		RJ2		RJ1		RJ2		RJ1	RJ2	RJ1	RJ2
	NO	NC	NO	NC	NO	NC	NO	NC	NO	NC	NO	NC	NO	NO	NO	NO
250V AC	12A	12A	8A	8A	12A	12A	8A	8A	7.5A	7.5A	4A	4A	12A	8A	6A	3A
30V DC	12A	6A	8A	4A	12A	6A	8A	4A	6A	3A	4A	2A	12A	8A	2.5A	2A

Note: According to the utilization categories of IEC60947-5-1

Coil Ratings

Rated Voltage	Coil Voltage Code	Without LED Indicator		With LED Indicator		Operating Characteristics (against rated values at 20°C)			Power Consumption			
		Rated Current (mA) ±15% (at 20°C)		Coil Resistance (Ω) ±10% (at 20°C)	Rated Current (mA) ±15% (at 20°C)		Coil Resistance (Ω) ±10% (at 20°C)	Minimum Pickup Voltage		Dropout Voltage	Maximum Continuous Applied Voltage (Note)	
		50 Hz	60 Hz		50 Hz	60 Hz						
AC 50/60 Hz	24V AC	A24	43.9	37.5	243	47.5	41.1	243	80% maximum	30% minimum	140%	Approx. 0.9 VA (60Hz)
	110V AC	A110	9.6	8.2	5270	9.5	8.1	5270				
	120V AC	A120	8.8	7.5	6400	8.7	7.4	6400				
	220V AC	A220	4.8	4.1	21530	4.8	4.1	21530				
	230V AC	A230	4.6	3.9	24100	4.6	3.9	24100				
	240V AC	A240	4.3	3.7	25570	4.3	3.7	25570				
DC	12V	D12	44.2		271	48.0		271	70% maximum	10% minimum	170%	Approx. 0.53W
	24V	D24	22.1		1080	25.7		1080				
	48V	D48	11.0		4340	10.7		4340				
	100-110V	D100	5.3-5.8		18870	5.2-5.7		18870			160%	

Note: Maximum continuous applied voltage is the maximum voltage that can be applied on relay coils.

Specifications

Type		RJ1S	RJ2S
Number of Poles		1-pole	2-pole
Contact Configuration		SPDT	DPDT
Contact Material		Silver-nickel alloy	
Degree of Protection		IP40	
Contact Resistance (initial value) (*1)		50 mΩ maximum	
Operate Time (*2)		15 ms maximum	
Release Time (*2)		10 ms maximum (with diode: 20 ms maximum)	
Dielectric Strength	Between contact and coil	5000V AC, 1 minute	5000V AC, 1 minute
	Between contacts of the same pole	1000V AC, 1 minute	1000V AC, 1 minute
	Between contacts of different poles	—	3000V AC, 1 minute
Vibration Resistance	Operating extremes	10 to 55 Hz, amplitude 0.75 mm	
	Damage limits	10 to 55 Hz, amplitude 0.75 mm	
Shock Resistance	Operating extremes	NO contact: 200 m/s ² , NC contact: 100 m/s ²	
	Damage limits	1000 m/s ²	
Electrical Life (rated load)		AC load: 200,000 operations minimum (operation frequency 1800 operations per hour) DC load: 100,000 operations minimum (operation frequency 1800 operations per hour)	
Mechanical Life (no load)		AC coil: 30,000,000 operations minimum (operation frequency 18,000 operations per hour) DC coil: 50,000,000 operations minimum (operation frequency 18,000 operations per hour)	
Operating Temperature (*3)		-40 to +70°C (no freezing)	
Operating Humidity		5 to 85% RH (no condensation)	
Weight (approx.)		19g	

Note: Above values are initial values.

*1: Measured using 5V DC, 1A voltage drop method.

*2: Measured at the rated voltage (at 20°C), excluding contact bounce time.

*3: 100% rated voltage.

RJ Series Slim Power Relays

Dimensions

• RJ1S Type

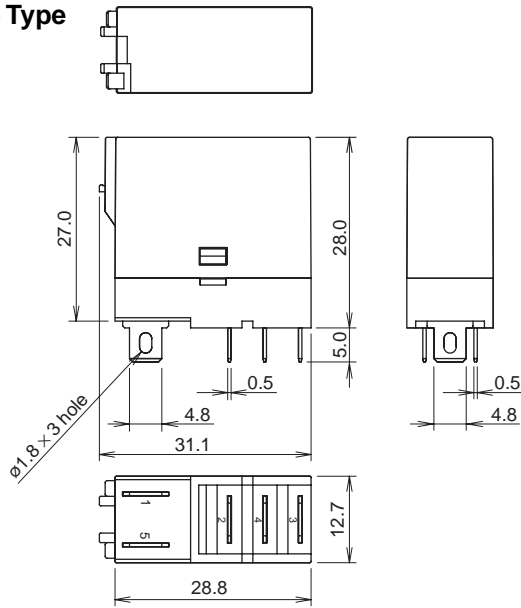

• RJ2S-CL Type

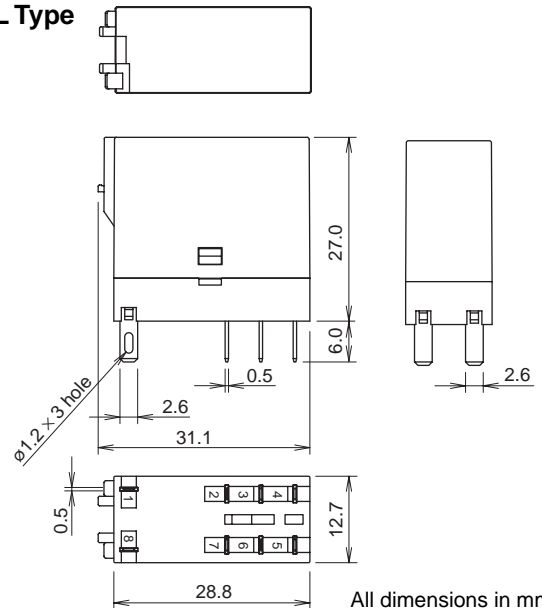

All dimensions in mm.

Internal Connection Diagrams

• RJ1S-CL-* Standard Type (w/LED Indicator)

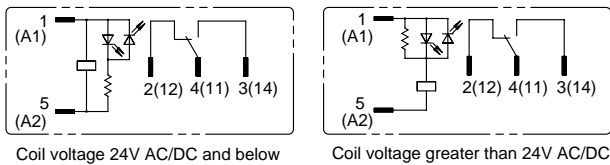

• RJ2S-CL-* Standard Type (w/LED Indicator)

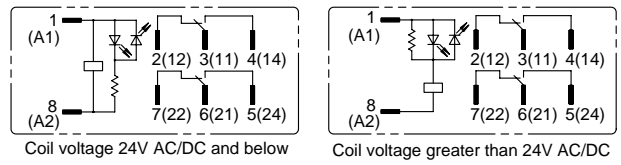

• RJ1S-C-* Simple Type

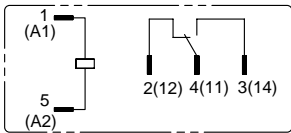

• RJ2S-C-* Simple Type

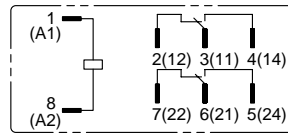

• RJ1S-CLD-* With Diode (w/LED Indicator)

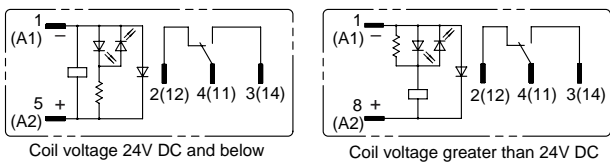

• RJ2S-CLD-* With Diode (w/LED Indicator)

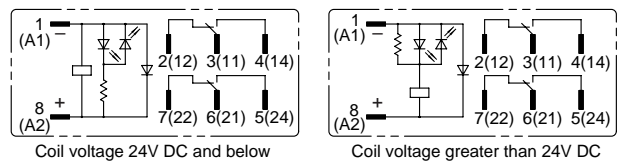

• RJ1S-CD-* With Diode

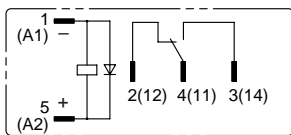

• RJ2S-CD-* With Diode

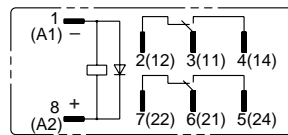

• RJ1S-CLD1-* With Diode (w/LED Indicator)

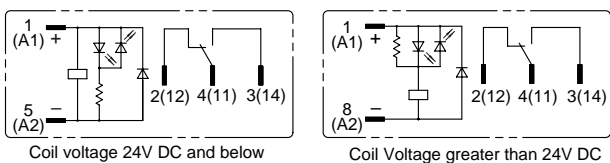

• RJ2S-CLD1-* With Diode (w/LED Indicator)

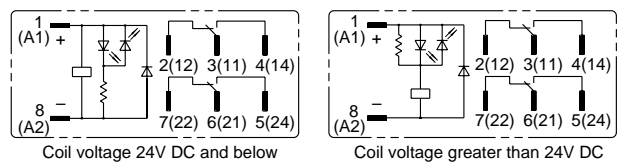

• RJ1S-CD1-* With Diode

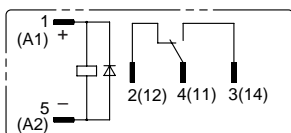

• RJ2S-CD1-* With Diode

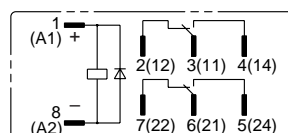

RJ Series Slim Power Relays

Electrical Life Curve

• RJ1 (resistive load)

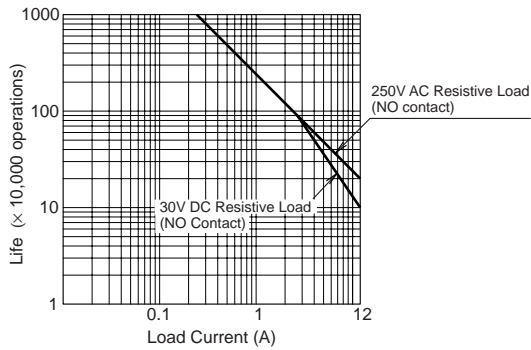

• RJ2 (resistive load)

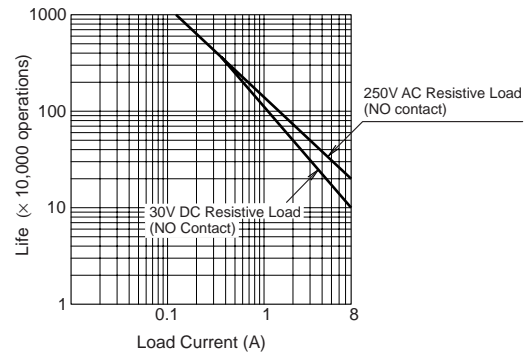

Maximum Switching Capacity

• RJ1 (resistive load)

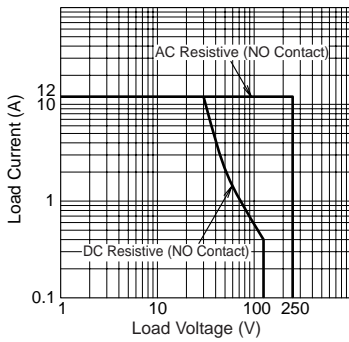

• RJ2 (resistive load)

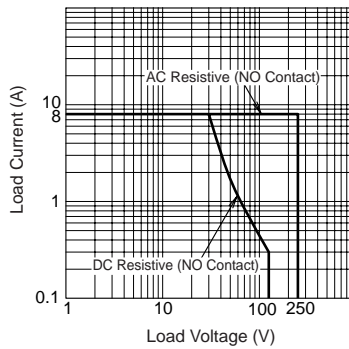

Operating Temperature and Coil Temperature Rise

• RJ1

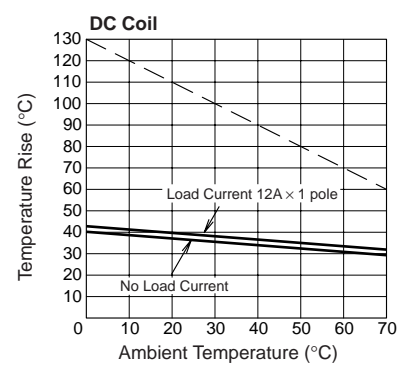
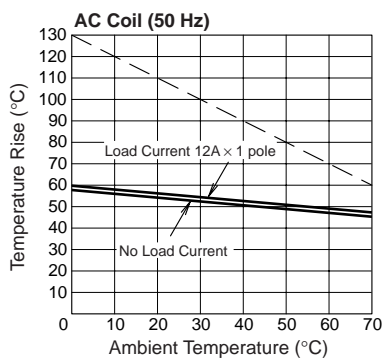
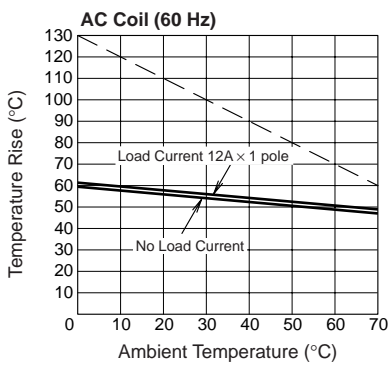

• RJ2

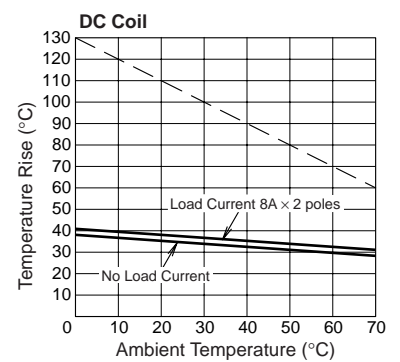
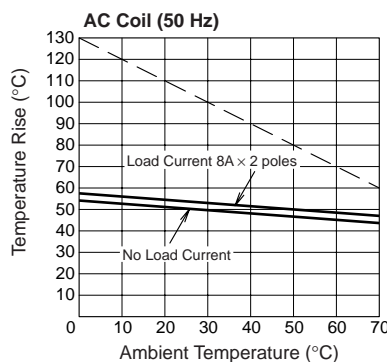
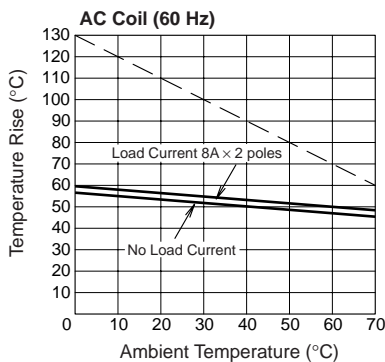

The above temperature rise curves show characteristics when 100% the rated coil voltage is applied. The slanted dashed line indicates allowable temperature rise for the coil at different ambient temperatures.

RJ Series Slim Power Relays

Instructions

Driving Circuit for Relays

- To make sure of correct relay operation, apply rated voltage to the relay coil.
- Input voltage for the DC coil:

A complete DC voltage is best for the coil power to make sure of stable relay operation. When using a power supply containing a ripple voltage, suppress the ripple factor within 5%. When power is supplied through a rectification circuit, the relay operating characteristics, such as pickup voltage and dropout voltage, depend on the ripple factor. Connect a smoothing capacitor for better operating characteristics as shown below.

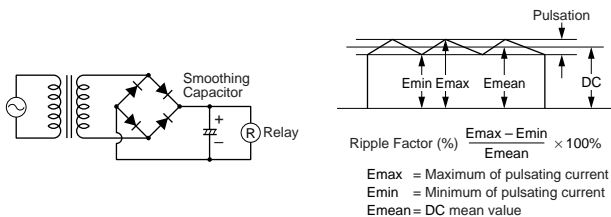

- Operating the relay in synchronism with AC load:

If the relay operates in synchronism with the AC power voltage of the load, the relay life may be reduced. If this is the case, select a relay in consideration of the required reliability for the load. Or, make the relay turn on and off irrespective of the AC power phase or near the point where the AC phase crosses zero voltage.

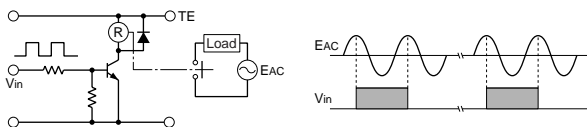

- Leakage current while relay is off:

When driving an element at the same time as the relay operation, a special consideration is needed for the circuit design. As shown in the incorrect circuit below, leakage current (I_o) flows through the relay coil while the relay is off. Leakage current causes the coil release failure or adversely affects the vibration resistance and shock resistance. Design a circuit as shown in the correct example.

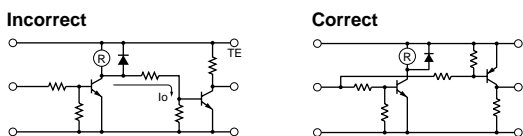

- Surge suppression for transistor driving circuits:

When the relay coil is turned off, a high-voltage pulse is generated, causing the transistor to deteriorate and sometimes to break. Be sure to connect a diode to suppress the counter electromotive force. Then, the coil release time becomes slightly longer. To shorten the coil release time, connect a Zener diode between the collector and emitter of the transistor. Select a Zener diode with a Zener voltage slightly higher than the power voltage.

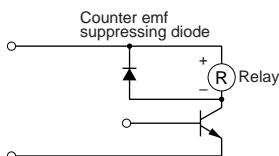

Protection for Relay Contacts

- The contact ratings show maximum values. Make sure that these values are not exceeded. When an inrush current flows through the load, the contact may become welded. If this is the case, connect a contact protection circuit, such as a current limiting resistor.
- Contact protection circuit:

When switching an inductive load, arcing causes carbides to form on the contacts, resulting in an increased contact resistance. In consideration of contact reliability, contact life, and noise suppression, use of a surge absorbing circuit is recommended. Note that

the release time of the load becomes slightly longer. Check the operation using the actual load. Incorrect use of a contact protection circuit will adversely affect switching characteristics. Four typical examples of contact protection circuits are shown in the following table:

RC		This protection circuit can be used when the load impedance is smaller than the RC impedance in an AC load power circuit. R: Resistor of approximately the same resistance value as the load C: 0.1 to 1 μF
		This protection circuit can be used for both AC and DC load power circuits. R: Resistor of approximately the same resistance value as the load C: 0.1 to 1 μF
Diode		This protection circuit can be used for DC load power circuits. Use a diode with the following ratings. Reverse withstand voltage: Power voltage of the load circuit \times 10 Forward current: More than the load current
Varistor		This protection circuit can be used for both AC and DC load power circuits. For a best result, when using on a power voltage of 24 to 48V AC/DC, connect a varistor across the load. When using on a power voltage of 100 to 240V AC/DC, connect a varistor across the contacts.

- Do not use a contact protection circuit as shown below:

	This protection circuit is very effective in arc suppression when opening the contacts. But, the capacitor is charged while the contacts are opened. When the contacts are closed, the capacitor is discharged through the contacts, increasing the possibility of contact welding.
	This protection circuit is very effective in arc suppression when opening the contacts. But, when the contacts are closed, a current flows to charge the capacitor, causing contact welding.

Generally, switching a DC inductive load is more difficult than switching a DC resistive load. Using an appropriate arc suppressor, however, will improve the switching characteristics of a DC inductive load.

Other Precautions



- General notice:
 - To maintain the initial characteristics, do not drop the relay or shock the relay.
 - The relay cover cannot be removed from the base during normal operation. To maintain the initial characteristics, do not remove the relay cover.
 - Use the relay in environments free from condensation, dust, sulfur dioxide (SO_2), and hydrogen sulfide (H_2S).
 - Make sure that the coil voltage does not exceed the applicable coil voltage range.
- Connecting outputs to electronic circuits:
 - When the output is connected to a load which responds very quickly, such as an electronic circuit, contact bouncing causes incorrect operation of the load. Take the following measures into consideration.
 - Connect an integral circuit.
 - Suppress the pulse voltage due to bouncing within the noise margin of the load.
- UL- and CSA-approved ratings may differ from product rated values determined by IDEC.
- Do not use relays in the vicinity of strong magnetic field, as this may affect relay operation.

SJ Series Relay Sockets

Slim, space-saving relay sockets.

Release lever allows for easy maintenance in narrow spaces.

- 15.5-mm wide
- Standard screw terminal and finger-safe screw terminal are available.
- Degree of protection IP20 (finger-safe screw terminal)
- The release lever makes installation and removal of relays inside small panels simple and quick.
- RoHS compliant (EU directive 2002/95/EC)
- UL recognized, CSA certified, EN compliant.

Standard	Mark	Approval organization / File No.
UL508		UL File No. E62437
CSA C22.2 No. 14		166730 (LR84913)
EN60999		EC Low Voltage Directive (Finger-safe screw terminal only)

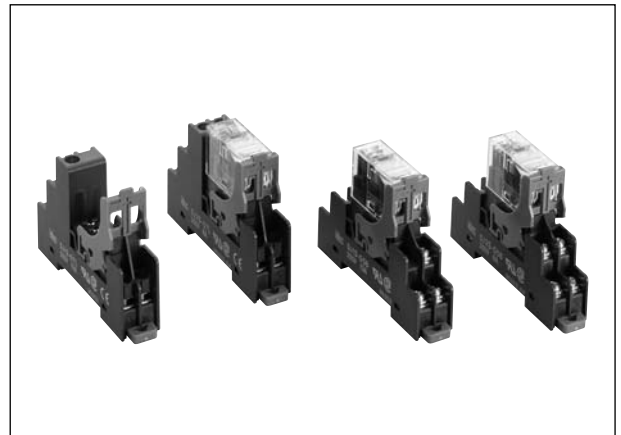

Types

Type	Type No.	
	1-pole	2-pole
Standard Screw Terminal	SJ1S-05B	SJ2S-05B
Finger-safe Screw Terminal	SJ1S-07L	SJ2S-07L

Note: Release lever is supplied with each socket.

Specifications

Type	SJ1S	SJ2S
Rated Current	12A	8A
Rated Insulation Voltage	250V AC/DC	
Applicable Wire	2 mm ² maximum (14 AWG)	
Applicable Crimping Terminal	2 mm ² × 2	
Recommended Tightening Torque	0.6 to 1.0 N·m (maximum tightening torque: 1.2 N·m)	
Screw Terminal Style	M3 slotted Phillips screw	
Terminal Strength	Wire tensile strength: 50N minimum	
Dielectric Strength	Between live and dead metal parts: 2000V AC, 1 minute Between contact and coil: 4000V AC, 1 minute Between contacts of the same pole: 1000V AC, 1 minute	
Vibration Resistance	Damage limits: 90 m/s ² Resonance: 10 to 55 Hz, amplitude 0.75 mm	
Shock Resistance	Damage limits: 1000 m/s ²	
Operating Temperature	-40 to +70°C (no freezing)	
Operating Humidity	5 to 85% RH (no condensation)	
Degree of Protection	IP20 (finger-safe screw terminal)	
Weight (approx.)	30g	34g

Applicable Crimping Terminals

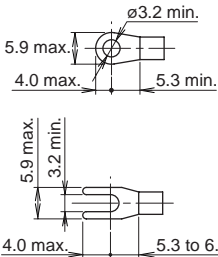
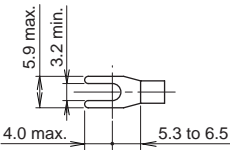
Standard Screw Terminal	Finger-safe Screw Terminal
	

All dimensions in mm.

Note: Ring tongue terminals cannot be used on finger-safe sockets.

RJ Series Relay Sockets

Dimensions

• SJ1S-05B

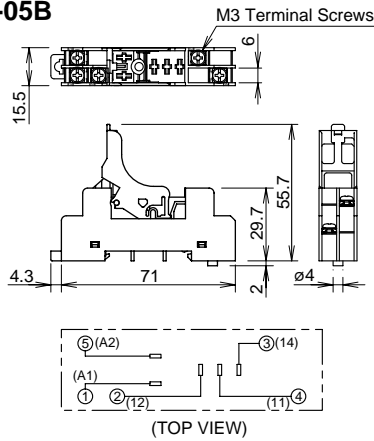

• SJ2S-05B

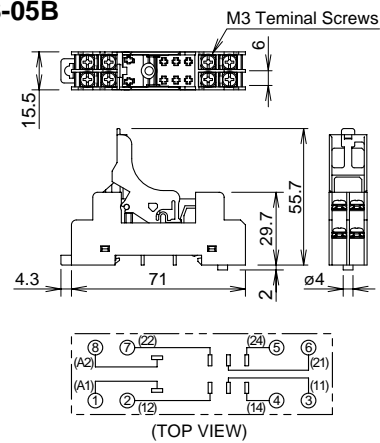

• SJ1S-07L

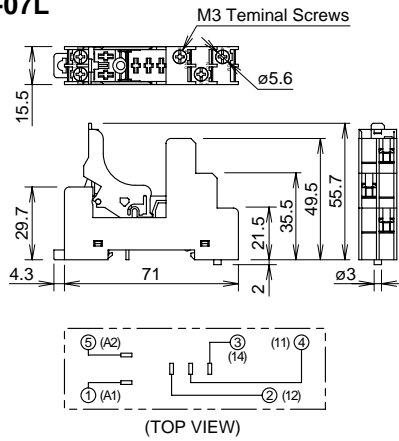

• SJ2S-07L

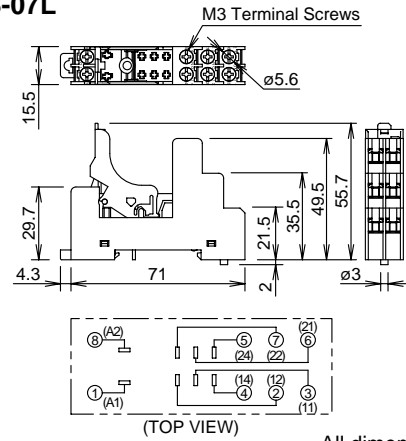



All dimensions in mm.

Replacement Parts

Description	Appearance	Material	Type No.	Ordering Type No.	Package Quantity
Release Lever		Plastic (gray)	SJ9Z-C1	SJ9Z-C1PN05	5

Accessories

Description	Appearance	Material	Type No.	Ordering Type No.	Package Quantity	Note
DIN Rail		Aluminum Weight: Approx. 200 g	BAA1000	BAA1000PN10	10	Length: 1 m Width: 35 mm
		Steel Weight: Approx. 200 g	BAP1000	BAP1000PN10		
Mounting Clip		Metal (zinc plated steel) Weight: Approx. 15 g	BNL5	BNL5PN10	1	Used on a DIN rail to fasten relay sockets. To prevent the sockets from damage, position the clip before fastening.
			BNL6	BNL6PN10		
DIN Rail Spacer		Plastic (black)	SA-406B	SA-406B	1	Thickness: 5 mm Used for adjusting spacing between sockets mounted on a DIN rail

Instructions

Installing relays

1. Unlock the release lever by pulling down as shown with arrow ①.
2. Press relay against the socket as shown with arrow ②. Make sure that the relay is firmly in place.
3. Confirm that the relay is securely installed in the socket. When installed properly, the relay and the socket look as shown in ③.

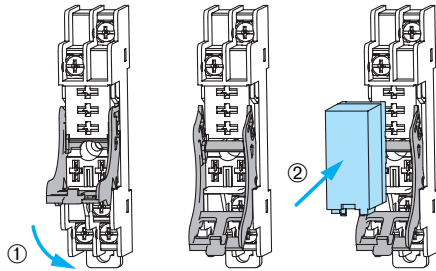

Latch is inserted into the groove on top of the relay.

The latch is not inserted into the groove on top of the relay.

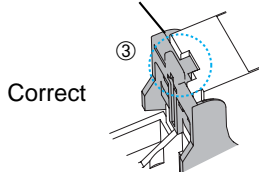

Correct

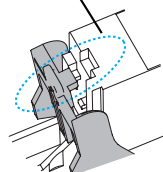

Incorrect

Caution

- Ensure that the relay is installed in the socket completely. When installed loosely, the relay may fall out, resulting in possible damage to the relay.

Removing the relay

- Pull down the release lever until the relay pops out of the socket. When removing, prevent the relay from falling out by lightly pressing the relay as shown below.

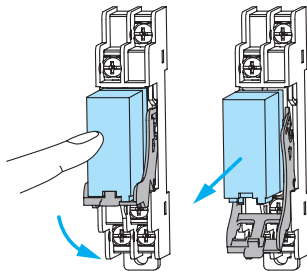

Caution

- The release lever is removable. Do not apply excessive force, otherwise the lever is removed from the socket causing the relay to fall out.
- When removing, take care that your finger is not caught between the release lever and the socket.

Panel mounting

- Insert the anti-rotation projection into the anti-rotation hole. Mount the socket onto the panel using M3 screws (not provided). Use a screwdriver with diameter of $\varnothing 5.5$ mm maximum.

Mounting Hole Layout

(SJ1S-05B, SJ2S-05B)

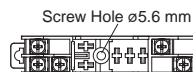
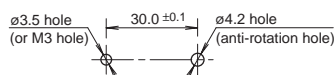

(SJ1S-07L, SJ2S-07L)

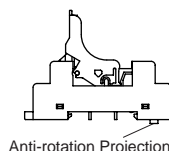
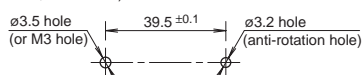

Anti-rotation Projection

Caution

When the release lever prevents the socket from being mounted on the panel directly, remove the release lever as instructed below. Ensure to reinstall the release lever after completing panel mounting.

Removing the release lever

- Pull down the release lever to the direction shown by the arrow until it touches the socket. Pull down further, and the lever will be detached from the socket.

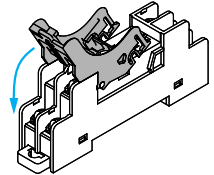

Caution

- Make sure that the relay has been removed from the socket before removing the release lever. If the release lever is removed when the relay is installed on the socket, the relay may fall out.

Installing the release lever

1. Attach part A to part B.
2. Slide the release lever in the direction of the arrow until part A runs out of part B.
3. Rotate the release lever, with the center of rotation at part C until part A touches the rotation axis.
4. Push the rib of the release lever against the socket.
5. Complete the installation.

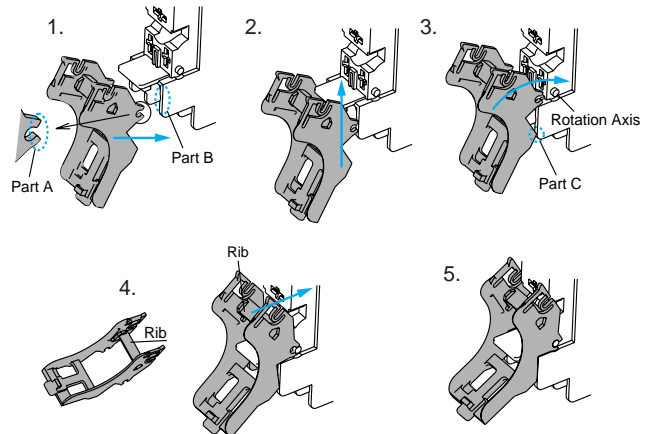

Applicable Screwdriver

• Standard Screw Terminal Type

Phillips: $\varnothing 6.4$ mm maximum
Slotted: Shown at right

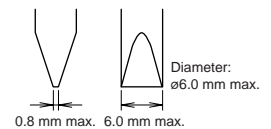

• Finger-safe Screw Terminal Type

Phillips: $\varnothing 5.5$ mm maximum
Slotted: Shown at right

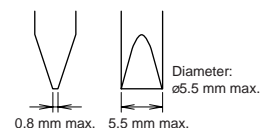

RU Series Universal Relays

Full featured universal miniature relays Designed with environment taken into consideration

- Two terminal styles: plug-in and PCB mount
- Non-polarized LED indicator available on plug-in relays
- Mechanical flag indicator available on plug-in relays
- Manual latching lever with color coding for AC or DC coil
- Snap-on yellow marking plate; optional marking plates are available in four other colors
- Maximum contact ratings: 10A (RU2), 6A (RU4), 3A (RU42)
- UL, CSA, c-UL, EN compliant



Safety Precautions

- Turn off power to the relay and the socket before starting installation, removal, wiring, maintenance, and inspection of the relays. Failure to turn power off may cause electrical shock or fire hazard.
- Observe specifications and rated values, otherwise electrical shock or fire hazard may be caused.
- Use wires of the proper size to meet the voltage and current requirements. Tighten the terminal screws on the relay socket to the proper tightening torque.

Specifications and other descriptions in this catalog are subject to change without notice.



IDEC CORPORATION

IDEC CORPORATION (USA)
1175 Elko Drive, Sunnyvale, CA 94089-2209, USA
Tel: +1-408-747-0550, Toll Free: (800) 262-IDEC, Fax: +1-408-744-9055
E-mail: opencontact@idec.com

IDEC CANADA LIMITED
Unit 22-151, Brunel Road Mississauga, Ontario, L4Z 1X3, Canada
Tel: +1-905-890-8561, Toll Free: (888) 317-4332, Fax: +1-905-890-8562
E-mail: sales@ca.idec.com

IDEC ELECTRONICS LIMITED
Unit 2, Beechwood, Chineham Business Park, Basingstoke, Hampshire
RG24 8WA, UK
Tel: +44-1256-321000, Fax: +44-1256-327755
E-mail: idec@uk.idec.com

IDEC ELEKTROTECHNIK GmbH
Wendenstrasse 331, D-20537 Hamburg, Germany
Tel: +49-40-25 30 54 10, Fax: +49-40-25 30 54 24
E-mail: service@idec.de

IDEC AUSTRALIA PTY. LTD.
2/3 Macro Court, Rowville, Victoria 3178, Australia
Tel: +61-3-9763-3244, Toll Free: 1800-68-4332, Fax: +61-3-9763-3255
E-mail: sales@au.idec.com

7-31, Nishi-Miyahara 1-Chome, Yodogawa-ku, Osaka 532-8550, Japan
Tel: +81-6-6398-2571, Fax: +81-6-6392-9731
E-mail: products@idec.co.jp

IDEC IZUMI ASIA PTE. LTD.
No. 31, Tannery Lane #05-01, Dragon Land Building, Singapore 347788
Tel: +65-6746-1155, Fax: +65-6844-5995
E-mail: generalinfo@idecasia.com.sg

IDEC IZUMI (H.K.) CO., LTD.
Unit 1505-07, DCH Commercial Centre No. 25, Westlands Road,
Quarry Bay, Hong Kong
Tel: +852-2803-8989, Fax: +852-2565-0171
E-mail: idec@idechk.com

IDEC IZUMI (Shanghai) Co., Ltd.
Room E, 15F, Majesty Building, No. 138 Pudong Avenue,
Shanghai 200120, P.R.C.
Tel: +86-21-5887-9181, Fax: +86-21-5887-8930
E-mail: idec@cn.idec.com

IDEC TAIWAN CORPORATION
8F, No. 79, Hsin Tai Wu Road, Sec. 1, Hsi-Chih, Taipei County, Taiwan
Tel: +886-2-2698-3244, Fax: +886-2-2698-3931
E-mail: service@idectwn.com.tw

www.idec.com